

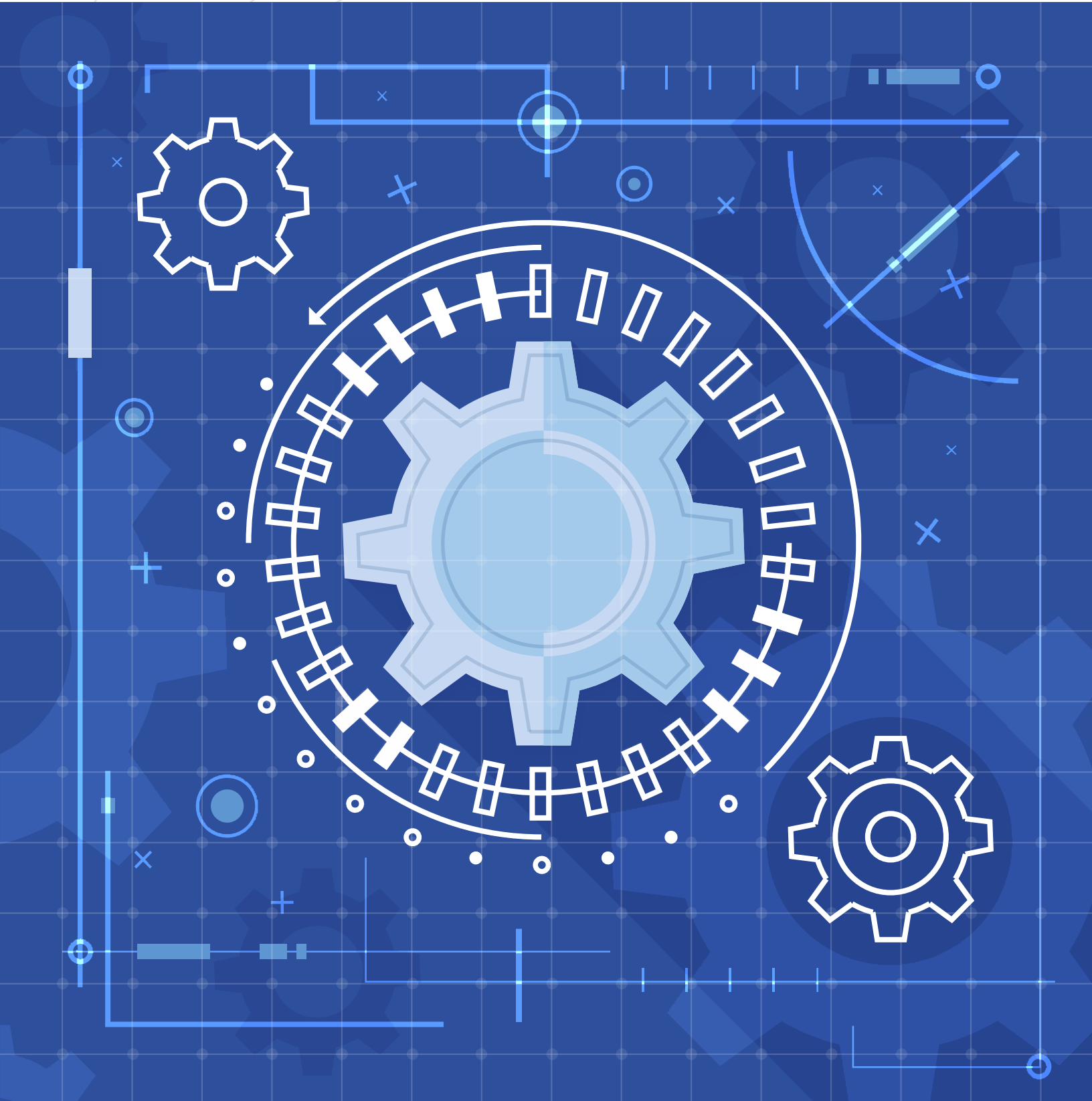

Advanced
Manufacturing,
Machining,
and Fabrication
of Heavy jobs



**SIDDHESH
ENGINEERS**





SIDDHESH ENGINEERS

About Us

Siddhesh Engineers is a 18000 square feet state-of-the-art facility located at A-65, 5-Star MIDC, Kolhapur, Maharashtra, India. Since its inception in 2009, facility has experienced steady customer and capability growth.

We have more than 25 years of experience in manufacturing and machining of heavy jobs for Defense, Machine Tools, Sugar, Cement, Textile, and Paper industries.

Siddhesh Engineers is equipped with the most advanced tooling and fixtures available in the global market. Most of our machines, cutting tools, and measuring equipment are from European and Japanese manufacturers such as Wohlhaupter, Hiedenhain, LINE, Binns & Berry, Csepel, VDF, VWF, and Mistubishi.

The latest additions to our productive capabilities are:
LINE CNC Planomiller : Table length: 5 meter, Table width:1.6 meter, Distance between column: 2 meter, Travel above the table: 1.5 meter
Sharda Planomiller: Table length: 5 meter, Table width: 1.3 meter, Distance between column: 2.5 meter, Travel above the table: 1.5 meter.

VARIOUS MACHINING OPERATIONS PERFORMED ON CNC PLANOMILLER ARE :

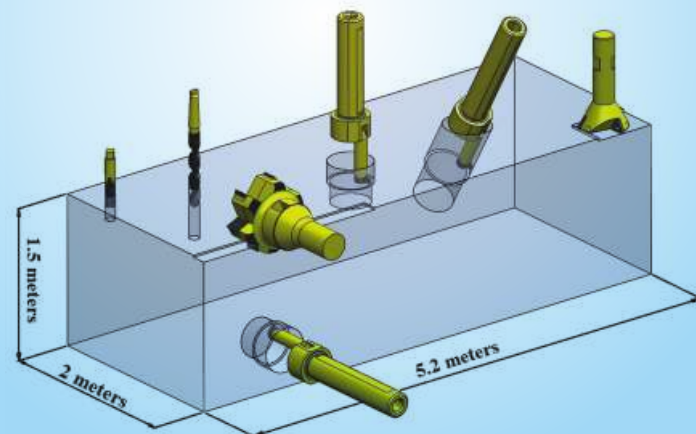

Our other existing machines include; Horizontal Boring Machine (100 mm spindle diameter), Heavy Duty Lathe (5.5 meter distance between center), Slotting Machine (800 mm stroke), Vertical Turret Lathe (up to 1.5 meter diameter), as well as a variety of sizes of Shaping Machines.

We are a customer centric company and we put sincere efforts to make sure that we fulfill our customer needs. Our commitment to safety, quality, and delivery time of the project to our customer is paramount to us. We highly value safety of our employees and customers hence our facility is equipped with world-class safety equipment.

We encourage you to contact us or visit our facility to learn more about how we can help you to expand your organization's capabilities in machining and manufacturing.



PLANOMILLER
X - 5.0 Meter
Y - 2.5 Meter
Z - 1.5 Meter

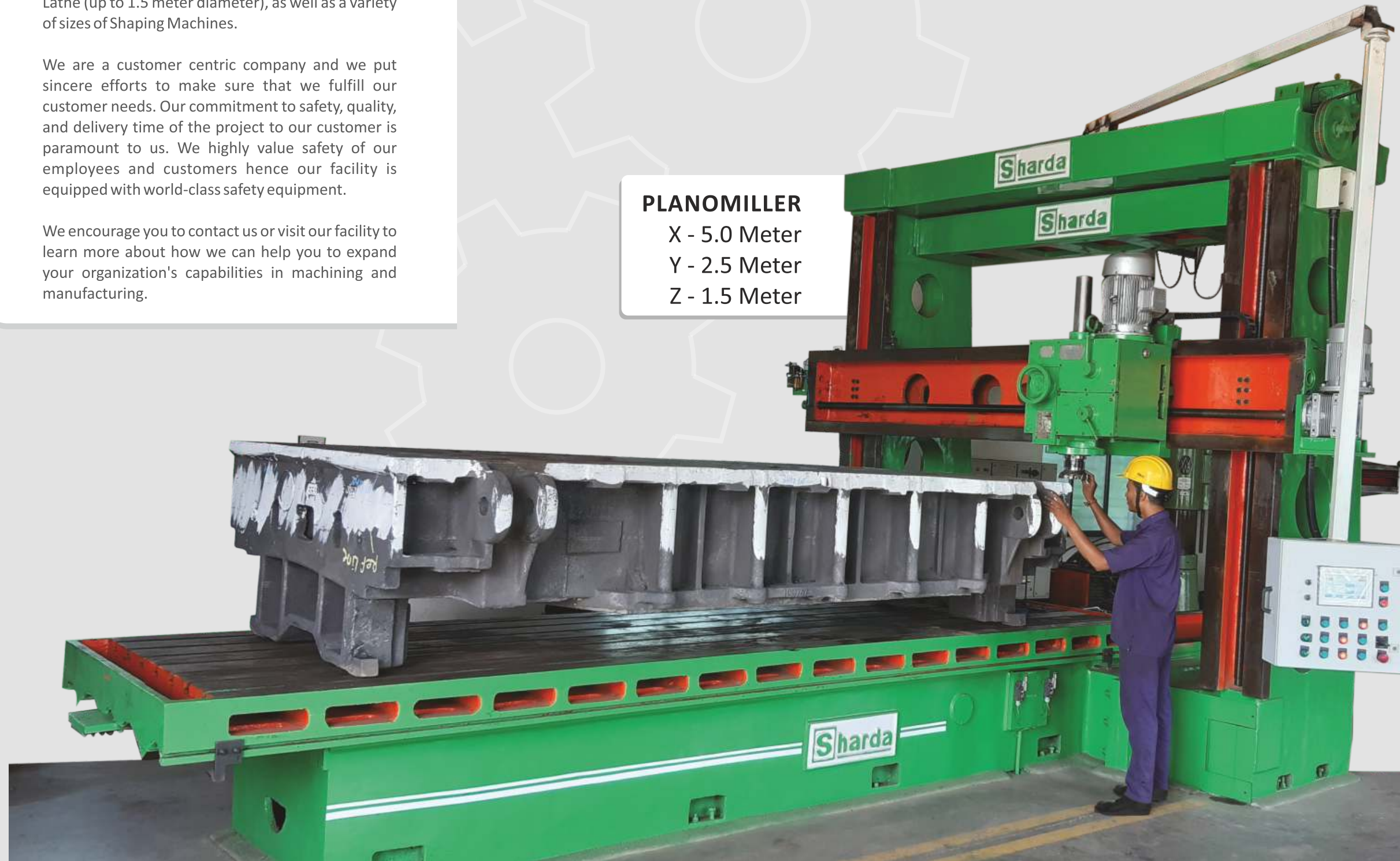

Machine :
 CNC PLANOMILLER
Manufacturer :
 LINE, FRANCE
CNC Control System :
 SINUMERIK 828D (Siemens)

Machining Range
 X - 5.2 Meter
 Y - 2.0 Meter
 Z - 1.5 Meter



OVERHEAD TRAVELLING CRANE
 Control: Electrical/Mechanical, Capacity: 10 ton + 5 ton = 15 ton





550 mm Swing x 5500 mm Lg. Heavy Duty Lathe, Bins & Berry

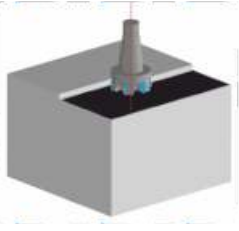
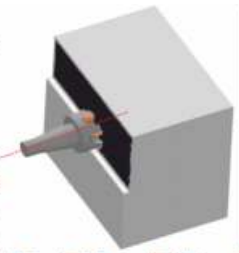

100 mm VWF Horizontal Boring Machine

CNC PLANOMILL MACHINING OPERATIONS & SPECIFICATIONS

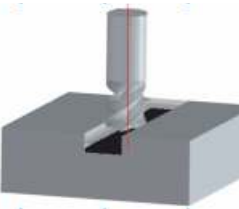
| Sr. No. | Machining Operation | Maximum Machining Range | Tooling | 3-Dimensional |
|---------|--|-------------------------|---------------------------------|---|
| 1 | Face Milling | Length - 5200 mm | Wohlhaupter, Mitsubishi, Others |  |
| | | Width - 2000 mm | | |
| | | Depth - 1500 mm | | |
| 2 | Side Milling | Length - 5200 mm | Wohlhaupter, Mitsubishi, Others |  |
| | | Width - Variable | | |
| | | Height - 500 mm | | |
| | | Total Height - 1500 mm | | |
| 3 | Angular Milling | Length - 5200 mm | Wohlhaupter, Mitsubishi, Others |  |
| | | Width - 2000 mm | | |
| | | Depth - Variable | | |
| 4 | Radial - Depth - Peripheral Milling | Length - 5200 mm | Wohlhaupter, Mitsubishi, Others |  |
| | | Width - 2000 mm | | |
| | | Depth - Variable | | |
| 5 | Slot Milling | Length - 5200 mm | Wohlhaupter, Mitsubishi, Others |  |
| | | Width - 2000 mm | | |
| | | Depth - Variable | | |

CNC PLANOMILL MACHINING OPERATIONS & SPECIFICATIONS

| Sr. No. | Machining Operation | Maximum Machining Range | Tooling | 3-Dimensional |
|---------|--------------------------|-------------------------|-------------------------|---|
| 6 | Vertical Boring | Diameter: 620 mm | Wohlhaupter, Mitsubishi |  |
| | | Depth: 500 mm | | |
| 7 | Angular Boring | Diameter: 620 mm | Wohlhaupter, Mitsubishi |  |
| | | Depth: 500 mm | | |
| | | Angle : 0 ° To 45 ° | | |
| 8 | Horizontal Boring | Diameter : 620 mm | Wohlhaupter, Mitsubishi |  |
| | | Depth : 300 mm | | |
| 9 | Drilling | Diameter : 60 mm | Various |  |
| 10 | Tapping | Diameter : 52 mm | Various |  |



SIDDHESH ENGINEERS

Contact:

Mahesh Parvate-Patil, Director
Cell : +91 9422049007 / 9421610111
Email : info@siddeng.com
siddhesheng@gmail.com

Facility & Office location:

Siddhesh Engineers
A-65, Five Star MIDC Kagal
Kolhapur - 416216, MH-India
Cell : +91 8530205333
Email : info@siddeng.com
siddhesheng@gmail.com
Web : www.siddeng.com

Main Office :

M.P. Engineers,
Block No. 1, Gat. No. 1589, Madhavnagar,
Kaneri, Kolhapur, MH, 416234.
Cell : +91 8484822172

Overseas Contact:

Girish Parvate-Patil, Chairman
Cell : +91 8484931272
+1 309-634-1641 (USA)
Email : info@siddeng.com
girish_parvate-patil@siddeng.com



Our Leadership Influence Gear

